

SPREADER

TRUCK

MOUNT

SPECIFICATIONS



DIMENSIONAL DATA FOR TRUCK MOUNTED MANURE SPREADERS

MODELS: SXI720 AND SXI865

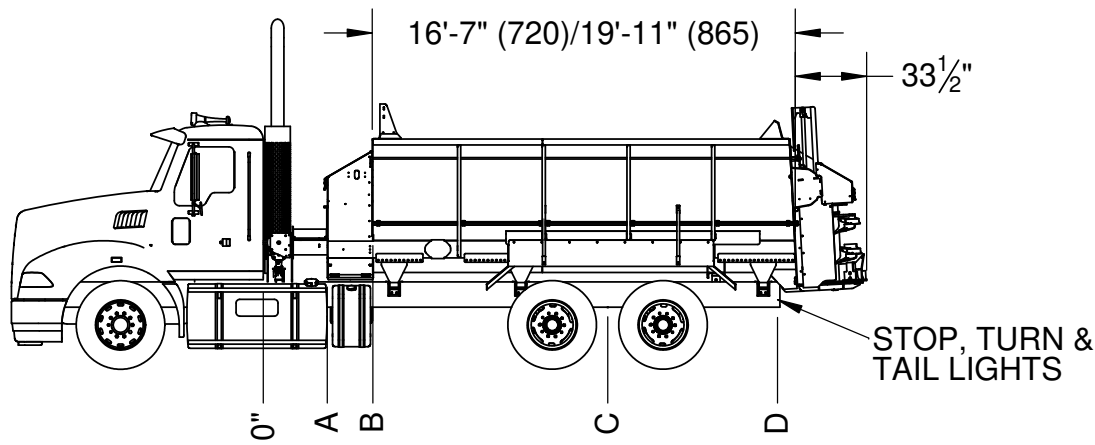

TRUCK PTO REQUIREMENTS-(DIRECT DRIVE)

TRUCK PTO-400 FT/LBS

DIRECT DRIVE REQUIREMENTS

GEARBOX DRIVE SYSTEM

100% OF ENGINE SPEED TO REACH 1000 RPM INPUT AT SPREADER.

SELECT TRUCK WITH AXLE, FRAME AND HORSEPOWER CONFIGURATION THAT MATCH CAPABILITIES OF SPREADER. ALWAYS FOLLOW FEDERAL, STATE & LOCAL LAWS FOR LIGHTING, WEIGHT & OPERATION. BE SURE SPREADER IS LOCATED ON TRUCK TO PROVIDE SAFE WEIGHT DISTRIBUTION.

LIGHTING SPECIFICATIONS

HIGHWAY LIGHT PACKAGE RECOMMENDED FOR ON ROAD TRANSPORT

SUPPLY A 7-PIN MALE & FEMALE PLUG OFF OF THE REAR OF THE CAB FOR LIGHT HOOK UP TO IMPLEMENT, LOCATED CENTRALLY BEHIND THE CAB. ORDER FROM MEYER MFG.

#56-0005-2 & #56-0014-1.

TAIL LIGHT CONVERTER

DEPENDING ON MAKE AND MODEL OF TRUCK, IT MAY BE NECESSARY TO INSTALL A LIGHT CONVERTER, MEYER MFG. #56-0028. CONVERTER ALLOWS SIGNAL LIGHTS AND BRAKE LIGHTS TO OPERATE ACCORDING TO D.O.T. LIGHTING REGULATIONS.

SIZE	A	B	C	D
720	33"	55"	182"	243"
865	33"	55"	202"	283"

SIZE	CU. FT. STRUCK	EMPTY WEIGHT	MOUNT BKT'S REQUIRED	AXLE	GVW	FRONT/REAR AXLES #S	MIN. ENGINE H.P.	CAB TO AXLE TRUNNION
720	468		3	TANDEM	64,000 #	18/46,000 OR 20/44,000	300	177"-187"
865	562		3	TANDEM	64,000 #	18/46,000 OR 20/44,000	300	197"-207"

FEMALE TRUCK PLUG

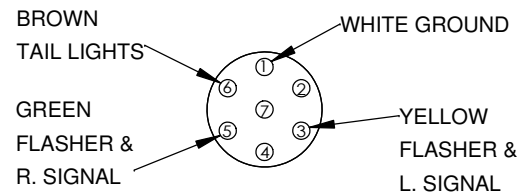

- #1-GROUND (WHITE OR RED FROM IMPLEMENT)
- #3-FLASHERS & L. SIGNAL (YELLOW FROM IMPLEMENT)
- #5-FLASHER & R. SIGNAL (GREEN FROM IMPLEMENT)
- #6-CLEARANCE LAMPS (BROWN FROM IMPLEMENT)

LIGHTING REQUIREMENTS
TRUCK MUST BE EQUIPPED WITH STOP, TURN & TAIL LIGHTS

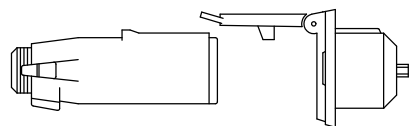

56-0005-2 56-0014-1

MEYER MANUFACTURING WILL NOT BE RESPONSIBLE FOR UNITS THAT ARE NOT SET UP ACCORDING TO THE SPECIFICATIONS ON THIS PAGE. SYSTEM FAILURE COULD OCCUR ALONG WITH POOR PERFORMANCE.

	NAME	DATE	 MEYER MFG CORP.						
DRAWN	Craig	12/19/2017							
REVISED			MATERIAL						
UNLESS OTHERWISE SPECIFIED: DIMENSIONS ARE IN INCHES TOLERANCES: FRACTIONAL ±1/32" ANGULAR: BEND ±.5° TWO PLACE DECIMAL ±.020" THREE PLACE DECIMAL ±.010"			TITLE: SXI720 & SXI865 TRUCK MOUNT SPECIFICATIONS						
PROPRIETARY AND CONFIDENTIAL THE INFORMATION CONTAINED IN THIS DRAWING IS THE SOLE PROPERTY OF MEYER MFG CORP. ANY REPRODUCTION IN PART OR AS A WHOLE WITHOUT THE WRITTEN PERMISSION OF MEYER MFG CORP. IS PROHIBITED.			<table border="1" style="width: 100%;"> <tr> <td>SIZE</td> <td>DWG. NO.</td> <td>REV</td> </tr> <tr> <td style="font-size: 2em; text-align: center;">A</td> <td style="text-align: center;">SXI-TRUCK-P-SPECS</td> <td style="text-align: center;">-</td> </tr> </table>	SIZE	DWG. NO.	REV	A	SXI-TRUCK-P-SPECS	-
SIZE	DWG. NO.	REV							
A	SXI-TRUCK-P-SPECS	-							
SCALE: 1:90		WT: 0.00	SHEET 1 OF 1						

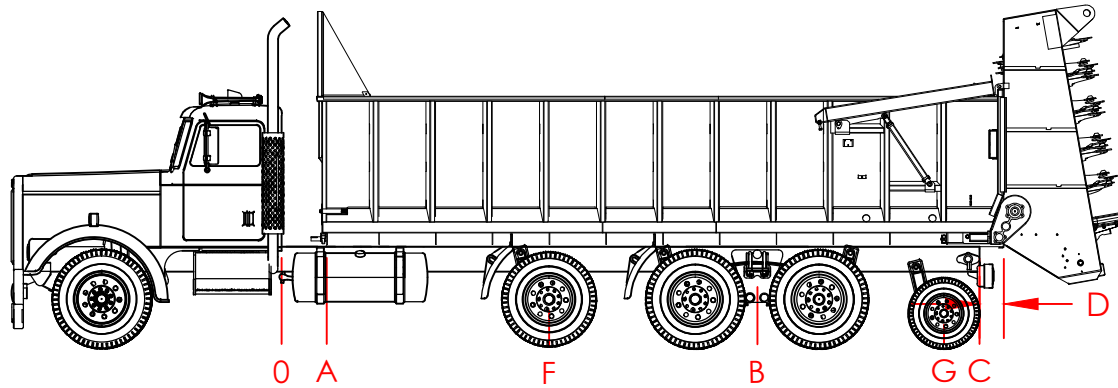

HYDRAULIC SPECIFICATIONS -TRUCK WET KIT PROVIDED BY CUSTOMER

HYDRAULIC WET KIT-APRON DRIVE
 25 GPM @ 3,000 PSI PEAK PRESSURE
 RELIEF VALVE INSTALLED & SET AT 3,000 PSI
 35-40 GALLON RESERVOIR FILLED W/30 GALLONS OF HYDRAULIC OIL
 3/4" HOSES REQUIRED WITH 3/4" NPT MALE SWIVEL ENDS FOR HYDRAULIC HOOKUP, HOSES TO EXTEND 30" REARWARD FROM A CENTER LOCATION ON THE BACK OF THE CAB

MECHANICAL DRIVE-EXPELLER DRIVE

TRUCK PTO DRIVE
 TRUCK PTO-400 FT/LBS INTERNAL TORQUE MINIMUM
 100% OF ENGINE SPEED REQUIRED W/MEYER RIGHT ANGLE GEARBOX DRIVE PACKAGE

Select truck with axle, frame and horsepower configurations that match box capacities. Always follow Federal, State and local laws for lighting, weight and operation. Be sure box is located on the truck to provide safe weight distribution on the truck.

SIZE	CU. FT. HEAPED	SPREADER WEIGHT*	AXLE	FRONT/REAR AXLES # S	MIN. ENGINE H.P.
9516	550	11,260#	TANDEM	18/46,000 OR 20/44,000	300
9520	755	12,300#	TANDEM	18/46,000 OR 20/44,000	300
9524	925	13,340#	TANDEM	18/46,000 OR 20/44,000	350
9524	925	13,340#	TRIDEM	18/46,000 OR 20/44,000	350
9524	925	13,340#	QUAD AXLE	18/46,000 OR 20/44,000	350
9530	1,180	14,900#	QUAD AXLE	20/44,000	400

* APPX WEIGHT W/S200 ATTACHMENT

SIZE	PUSHER AXLE				TAG AXLE		
	A	B	C	D	E	F	G
9516	19"	150"	199"	10"	261"	NA	NA
9520	19"	186"	247"	10"	309"	NA	NA
9524 TANDEM	19"	210"	295"	10"	357"	NA	NA
9524 TRIDEM	19"	216"	295"	10"	357"	113"	NA
9524 QUAD	19"	201"	295"	10"	357"	113"	285"
9530	19"	254"	367"	10"	429"	168"	340"

A-CAB TO FRONT OF BOX
 B-CAB TO CENTER OF AXLE
 C-CAB TO REAR OF TRUCK FRAME
 D-MAXIMUM SPREADER OVERHANG 10"
 E-CAB TO REAR OF SPREADER

SCALE EQUIPPED TRUCKS

Truck/Box combinations equipped with optional scale packages require additional truck frame strength due to concentrations of load. All scale equipped units require a double framed truck. Noncompliant frame specifications will void Meyer warranty for related damage.

LIGHTING SPECIFICATIONS

HIGHWAY LIGHT PACKAGE RECOMMENDED FOR ON ROAD TRANSPORT

CUSTOMER TO SUPPLY A 7-PIN MALE & FEMALE PLUG OFF OF THE REAR OF THE CAB FOR LIGHT HOOK UP TO IMPLEMENT, LOCATED CENTRALLY BEHIND THE CAB. ORDER PART #56-0005-2 & 56-0014-1 FROM MEYER MANUFACTURING CORPORATION.

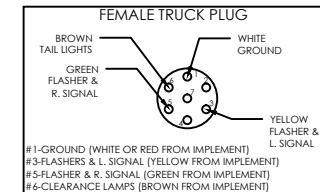
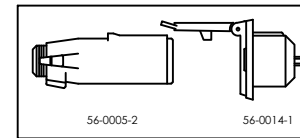

TAIL LIGHT CONVERTER

DEPENDING ON MAKE AND MODEL OF TRUCK IT MAY BE NECESSARY TO INSTALL A LIGHT CONVERTER, MEYER #56-0028. CONVERTER ALLOWS SIGNAL LIGHTS AND BRAKE LIGHTS TO OPERATE ACCORDING TO DOT LIGHTING REGULATIONS.

NAME	DATE	MEYER MFG CORP.	
DRAWN BY	JAA	12/11/2018	
CHECKED			MATERIAL:
UNLESS OTHERWISE SPECIFIED: DIMENSIONS ARE IN INCHES TOLERANCES: FRACTIONAL ± 1/32" ANGULAR: BEND ± 0.5° TWO PLACE DECIMAL ± 0.02" THREE PLACE DECIMAL ± 0.005"			TITLE: 9500 TRUCK MOUNT SPECIFICATIONS
PROPRIETARY AND CONFIDENTIAL THE INFORMATION CONTAINED IN THIS DRAWING IS THE SOLE PROPERTY OF MEYER MFG CORP. ANY REPRODUCTION IN PART OR AS A WHOLE WITHOUT THE WRITTEN PERMISSION OF MEYER MFG CORP. IS PROHIBITED.			SIZE A
DWG. NO. 9500 TRUCK MOUNT SPECIFICATIONS		REV. -	
SCALE: 1:1	WT: XX.XX	SHEET 1 OF 1	